



# GP12-9.0 (12V9.0Ah)

GP12-9.0 is a general purpose battery with 5 years life in standby service, or more than 260 cycles at 100% D.O.D by cyclic use. As with all GetPower batteries, all GP models are rechargeable, highly efficient, leak proof and maintenance free.



## Specification

Cells Per Unit	6
Voltage Per Unit	12
Capacity	9.0Ah@20hr-rate to 1.75V per cell @25°C
Weight	Approx. 2.45 Kg
Max. Discharge Current	90 A (5 sec)
Internal Resistance	Approx. 14 mΩ
Operating Temperature Range	Discharge: -20°C~60°C Charge: 0°C~50°C Storage: -20°C~60°C
Normal Operating Temperature Range	25°C ± 5°C
Float charging Voltage	13.6 to 13.8 VDC/unit Average at 25°C
Recommended Maximum Charging Current Limit	2.7 A
Equalization and Cycle Service	14 4.to 15 0.VDC/unit Average at 25°C
Self Discharge	GetPower batteries can be stored for more than 6 months at 25°C. Please charge batteries before using. For higher temperature, the time interval will be shorter.
Terminal	Faston tab 250(F2)
Container Material	A. B. S. (UL94-HB) Flammability resistance of UL94-V2 can be available upon request.



## Dimensions

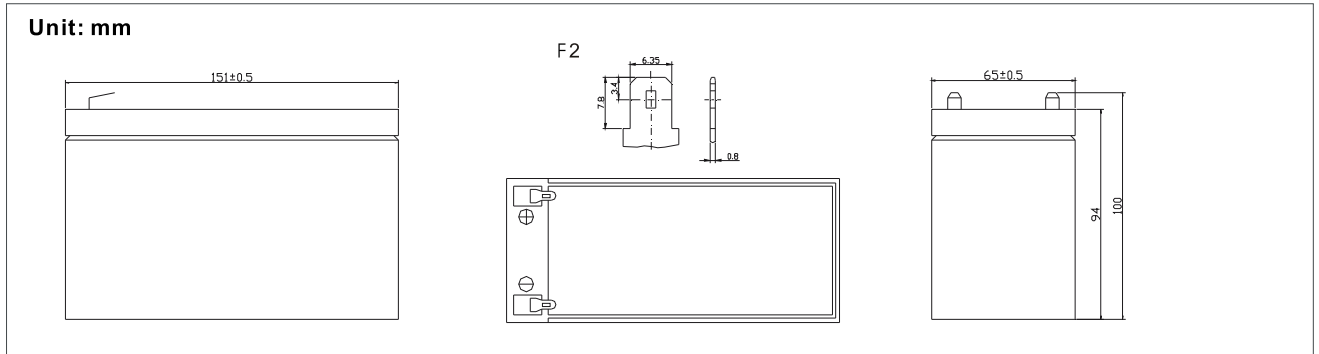

### Constant Current Discharge Characteristics Unit: A(25°C)

F.V/Time	5MIN	10MIN	15MIN	30MIN	1HR	2HR	3HR	4HR	5HR	8HR	10HR	20HR
1.60V	37.4	25.0	19.2	10.6	6.25	3.74	2.30	1.89	1.52	1.12	0.88	0.50
1.67V	35.0	23.3	18.0	10.4	6.21	3.72	2.30	1.88	1.51	1.12	0.87	0.48
1.70V	33.1	22.6	17.6	10.3	6.17	3.71	2.29	1.87	1.50	1.12	0.86	0.47
1.75V	29.9	21.1	16.7	10.1	6.08	3.66	2.28	1.86	1.49	1.12	0.86	0.45
1.80V	26.7	19.7	15.8	9.84	5.99	3.60	2.26	1.85	1.49	1.11	0.84	0.43
1.85V	23.5	18.2	14.9	9.59	5.90	3.55	2.24	1.85	1.48	1.11	0.83	0.42

### Constant Power Discharge Characteristics Unit: W(25°C)

F.V/Time	5MIN	10MIN	15MIN	30MIN	1HR	2HR	3HR	4HR	5HR	8HR	10HR	20HR
1.60V	72.0	46.8	38.0	21.1	12.5	7.48	4.60	3.76	3.57	2.24	1.76	0.98
1.67V	67.5	45.0	36.1	20.8	12.4	7.43	4.59	3.75	3.55	2.24	1.74	0.95
1.70V	66.2	43.7	35.3	20.6	12.4	7.42	4.58	3.75	3.54	2.22	1.72	0.93
1.75V	59.8	41.9	33.4	20.1	12.2	7.30	4.55	3.73	3.53	2.21	1.70	0.89
1.80V	53.4	39.2	31.6	19.7	12.0	7.20	4.52	3.70	3.52	2.21	1.67	0.86
1.85V	47.0	36.5	29.7	19.2	11.8	7.09	4.48	3.67	3.51	2.21	1.65	0.84

All mentioned values are average values.

# GP12-9.0

# 12V9.0Ah



**GetPower**

### Temperature effects curve

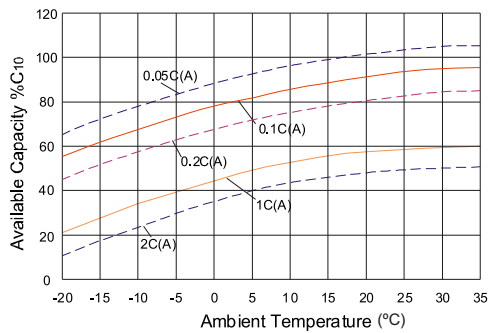

### Storage characteristic

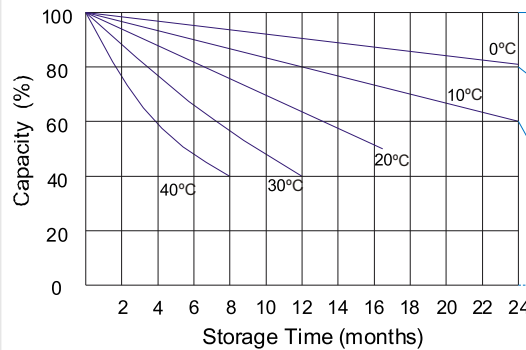

Supplementary charge required (Carry out supplementary charge before use if 100% capacity is required)

Supplementary charge required before use. This supplementary charge will help to recover the capacity and should be made as early as possible.

Supplementary charge may often fail to recover the capacity. The battery should never be left standing till this state is reached

Supplementary charge and storage guidelines

### Life characteristics of cyclic use

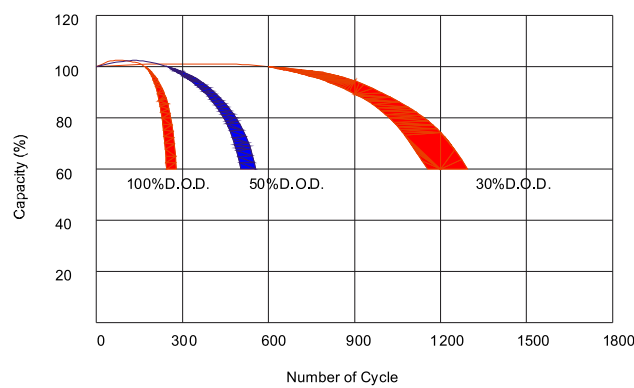

### Effect of temperature on long term float life

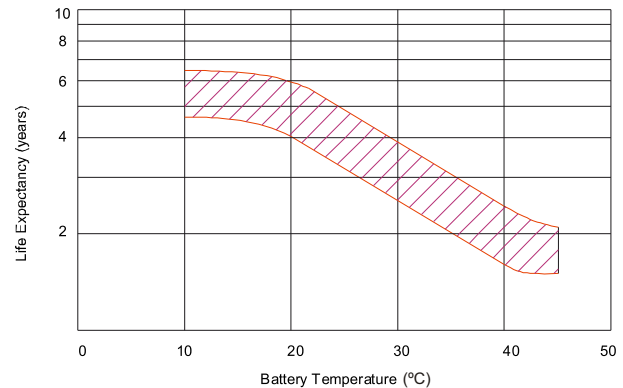

### Charge characteristic Curve for standby use

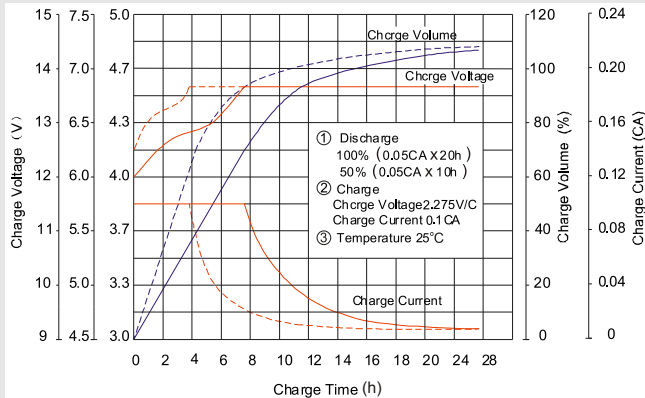

### Discharge characteristic Curve

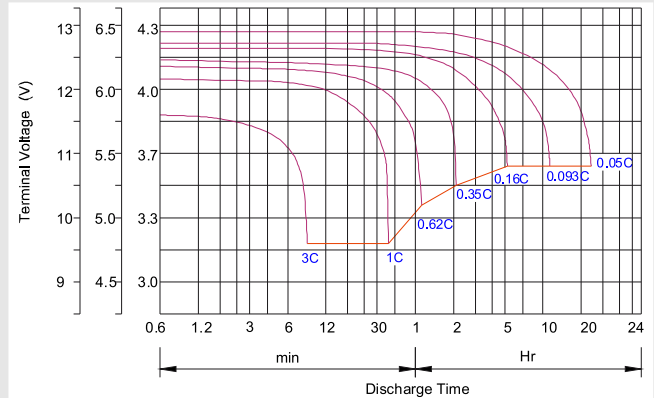

### Charging Procedures

Application	Charge Voltage (V)			Max. Charge Current
	Temperature	Set point	Allowable range	
Cycle Use	25°C	14.7	14.4~15.0	0.3C
Standby	25°C	13.7	13.6~13.8	0.3C

### Discharge Current VS. Discharge Voltage

Final Discharge Voltage V/cell	1.75V	1.70V	1.60V
Discharge Current (A)	(A) ≤ 0.2C	0.2C < (A) < 1.0C	(A) ≥ 1.0C

**Charge the batteries at least once every six months, if they are stored at 25°C.**

Charging Method:

Constant Voltage	14.4~15.0V, 5~11h, Max. Current 0.1CA
Constant Current	0.1CA x 5h
Fast	0.3CA x 1.7h

### Charging Procedures(6V series)

Application	Charge Voltage (V)			Max. Charge Current
	Temperature	Set point	Allowable range	
Cycle Use	25°C	7.35	7.25~7.45	0.3C
Standby	25°C	6.85	6.8~6.9	0.3C